

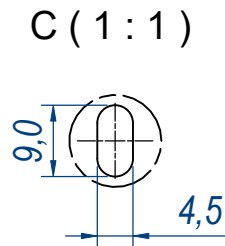

SEZ. A-A

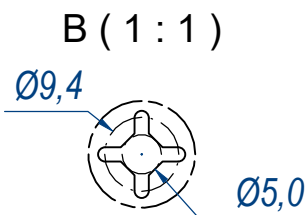

DESIGNED BY A. d'Alesio	CHECKED AND APPROVED BY T. Grassi	GENERAL TOLLERANCE SS-ISO-2768-1M	DATE 30/11/2023	CODE LE58350
RAM INDUSTRIE		DECRPTION	MATERIAL	UNIT mm
		DEVICE	PAIR WEIGHT WITH CARTON	SHEET 1 of 2
			PACKAGING	Carton 1 piece

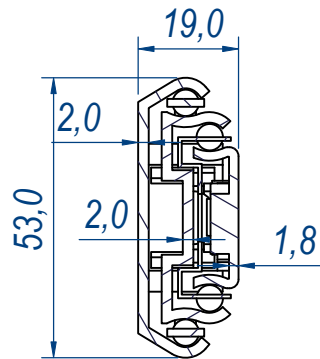
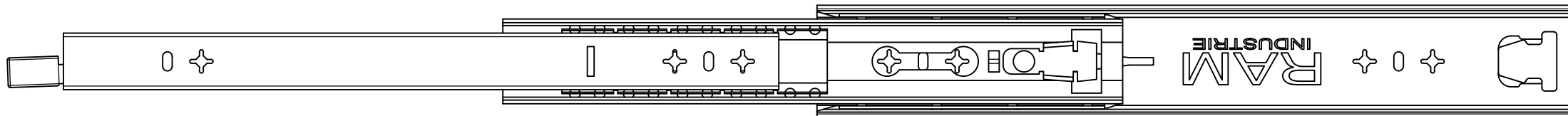
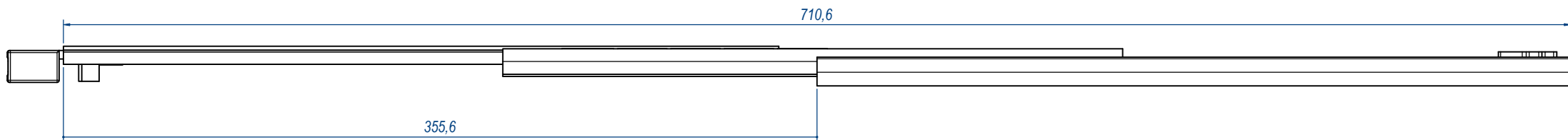
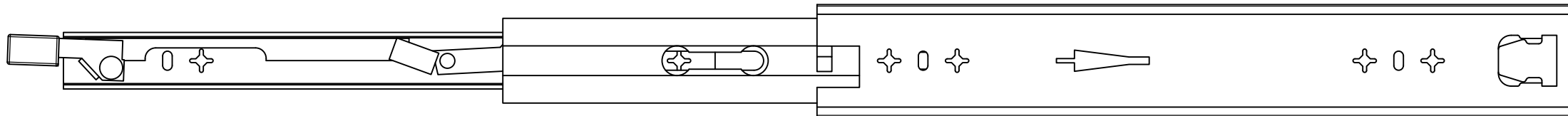

DESIGNED BY A. d'Alesio	CHECKED AND APPROVED BY T. Grassi	GENERAL TOLLERANCE SS-ISO-2768-1M	DATE 30/11/2023	CODE LE58350	
		DESCRIPTION	MATERIAL	UNIT mm	SHEET 2 of 2
		DEVICE	PAIR WEIGHT WITH CARTON	PACKAGING Carton 1 piece	

Property of RAM Industrie
Without its written authorization the present drawing shall neither be used for construction anyway, communicated to third parties, nor reproduced.