

SEZ. A-A

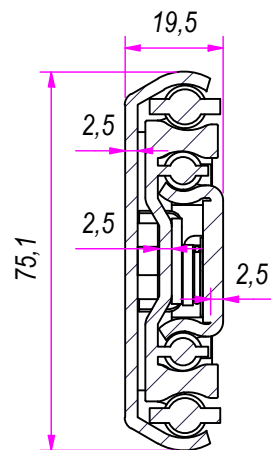

B (1:1)

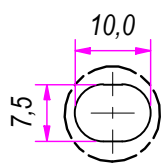

C (1:1)

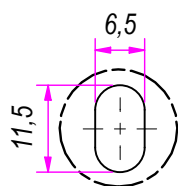

D (1:1)

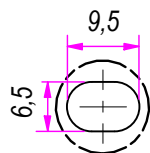

DESIGNED BY F.Dino	CHECKED AND APPROVED BY L. Paleari	REVISION	DATE 18/06/2021	CODE LO85900
		GENERAL TOLERANCE SS-ISO-2768-1M	UNIT mm	SCALE 1 of 2
		DESCRIPTION Lock-in and lock-out	MATERIAL Cold rolled steel	
			PAIR WEIGHT	02C

Property of RAM Industrie.
Without its written authorization the present drawing shall neither be used for construction anyway, communicated to third parties, nor reproduced.

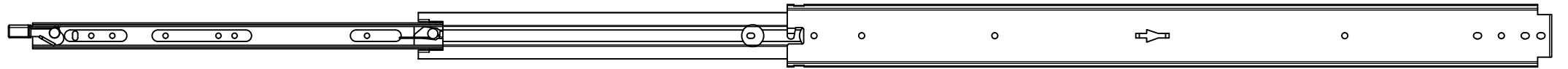

1819,5

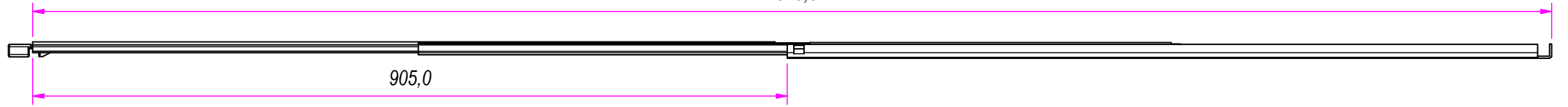

905,0

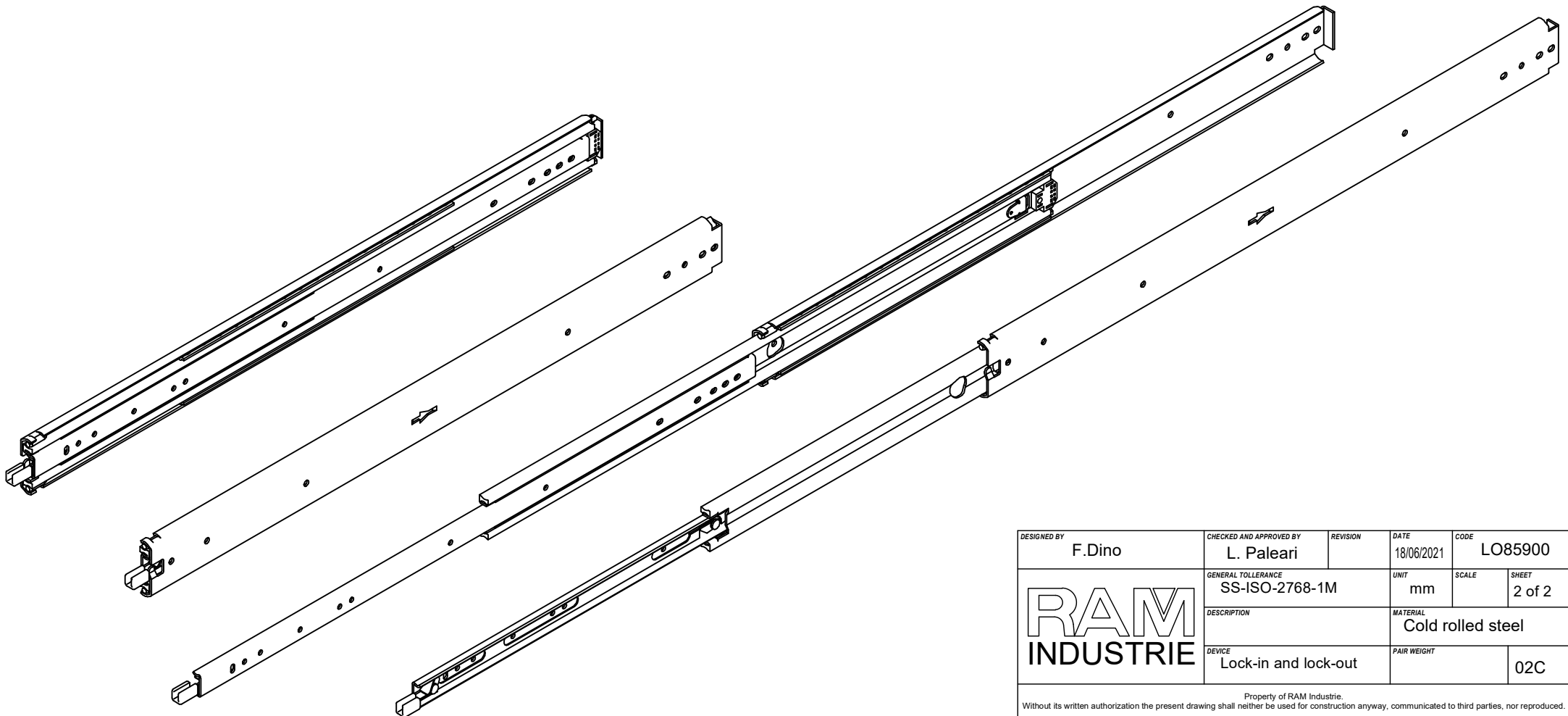
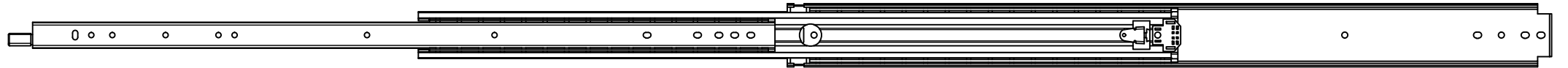

DESIGNED BY F.Dino	CHECKED AND APPROVED BY L. Paleari	REVISION	DATE 18/06/2021	CODE LO85900
		GENERAL TOLLERANCE SS-ISO-2768-1M	UNIT mm	SCALE SHEET 2 of 2
		DESCRIPTION Lock-in and lock-out	MATERIAL Cold rolled steel	
			PAIR WEIGHT	02C

Property of RAM Industrie.
Without its written authorization the present drawing shall neither be used for construction anyway, communicated to third parties, nor reproduced.