

SEZ. A-A

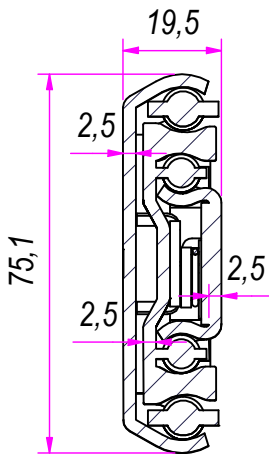

B (1:1)

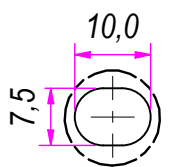

C (1:1)

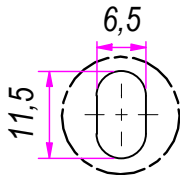

D (1:1)

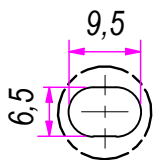

DESIGNED BY F.Dino	CHECKED AND APPROVED BY L. Paleari	REVISION	DATE 18/06/2021	CODE LO85600
GENERAL TOLERANCE SS-ISO-2768-1M		UNIT mm	SCALE	SHEET 1 of 2
DESCRIPTION Lock-in and lock-out			MATERIAL Cold rolled steel	
PAIR WEIGHT			02C	
Property of RAM Industrie. Without its written authorization the present drawing shall neither be used for construction anyway, communicated to third parties, nor reproduced.				



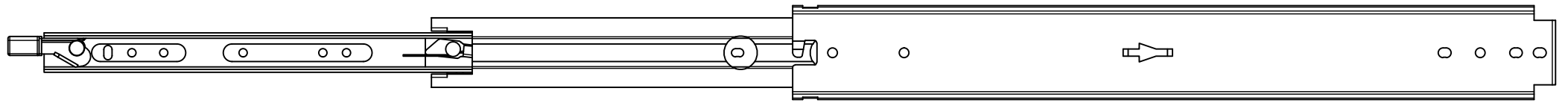

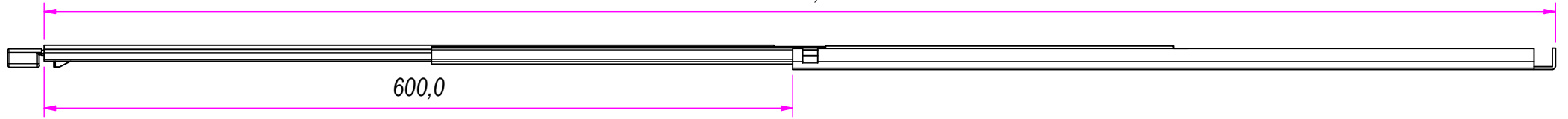

1209,5

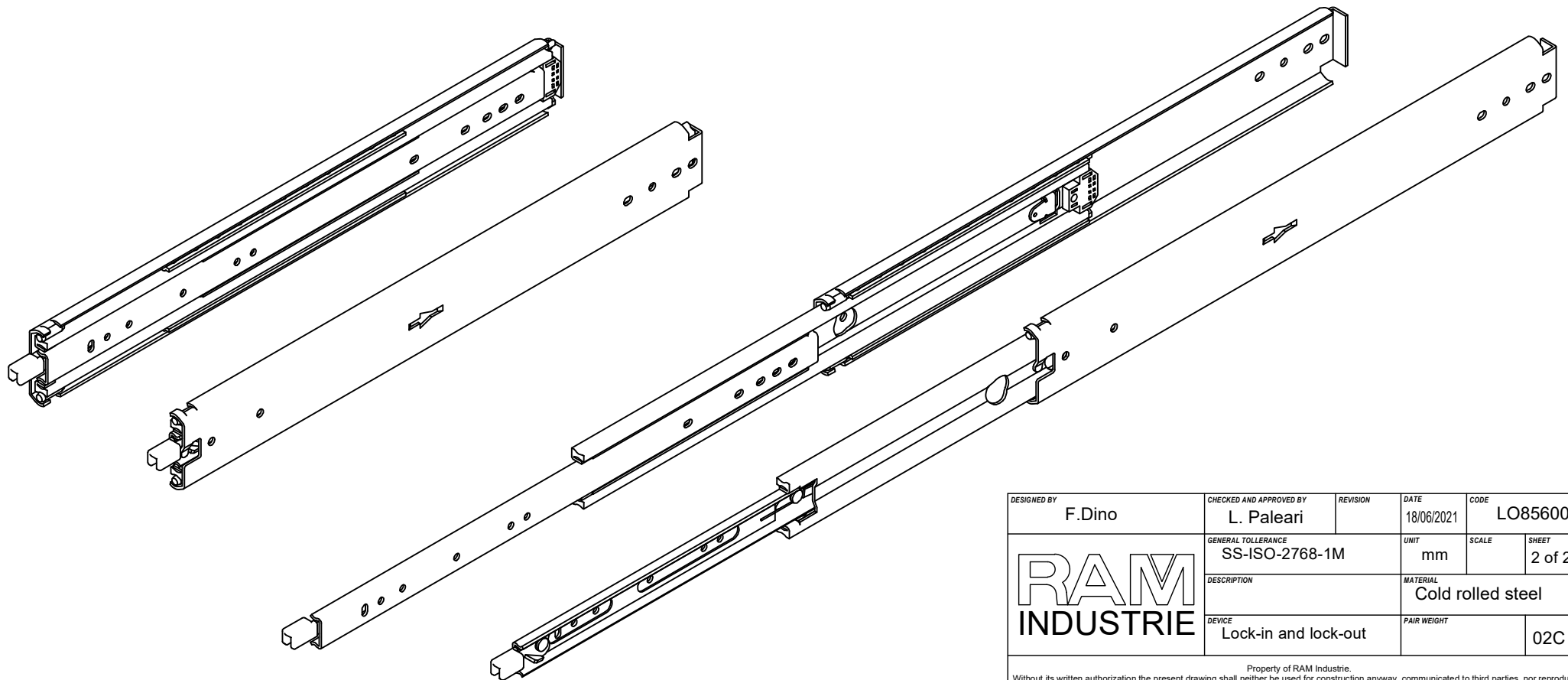
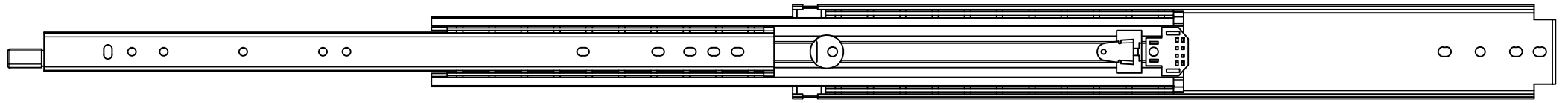

600,0



DESIGNED BY F.Dino	CHECKED AND APPROVED BY L. Paleari	REVISION	DATE 18/06/2021	CODE LO85600
		GENERAL TOLLERANCE SS-ISO-2768-1M	UNIT mm	SCALE SHEET 2 of 2
		DESCRIPTION DEVICE Lock-in and lock-out	MATERIAL Cold rolled steel PAIR WEIGHT 02C	

Property of RAM Industrie.  
Without its written authorization the present drawing shall neither be used for construction anyway, communicated to third parties, nor reproduced.