

SEZ. A-A

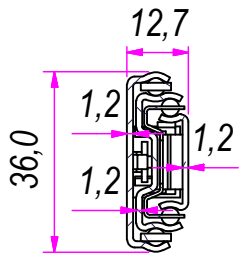

B (1:1)

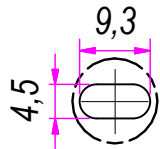

C (1:1)

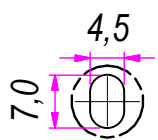

| | | | | |
|--------------------------------------|---------------------------------------|----------|-------------------------------|-----------------|
| DESIGNED BY F.Dino | CHECKED AND APPROVED BY L. Paleari | REVISION | DATE 21/06/2016 | CODE LO36300 |
| GENERAL TOLLERANCE SS-ISO-2768-1M | | | UNIT mm | SCALE 1 of 2 |
| DESCRIPTION Lock-out | | | MATERIAL Cold rolled steel | |
| DEVICE | | | PAIR WEIGHT 0,678 Kg | 02T |

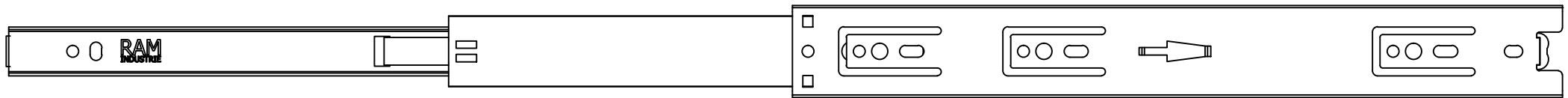

605,0

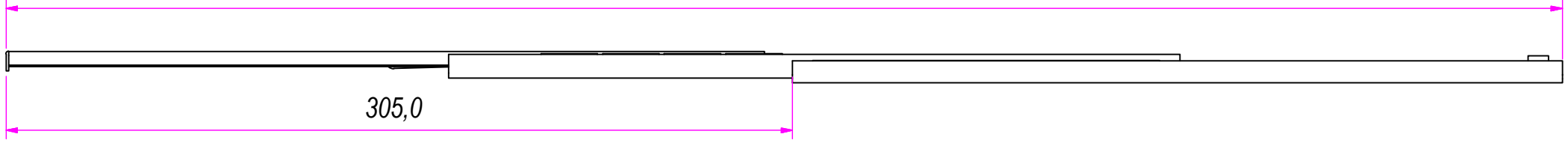

305,0

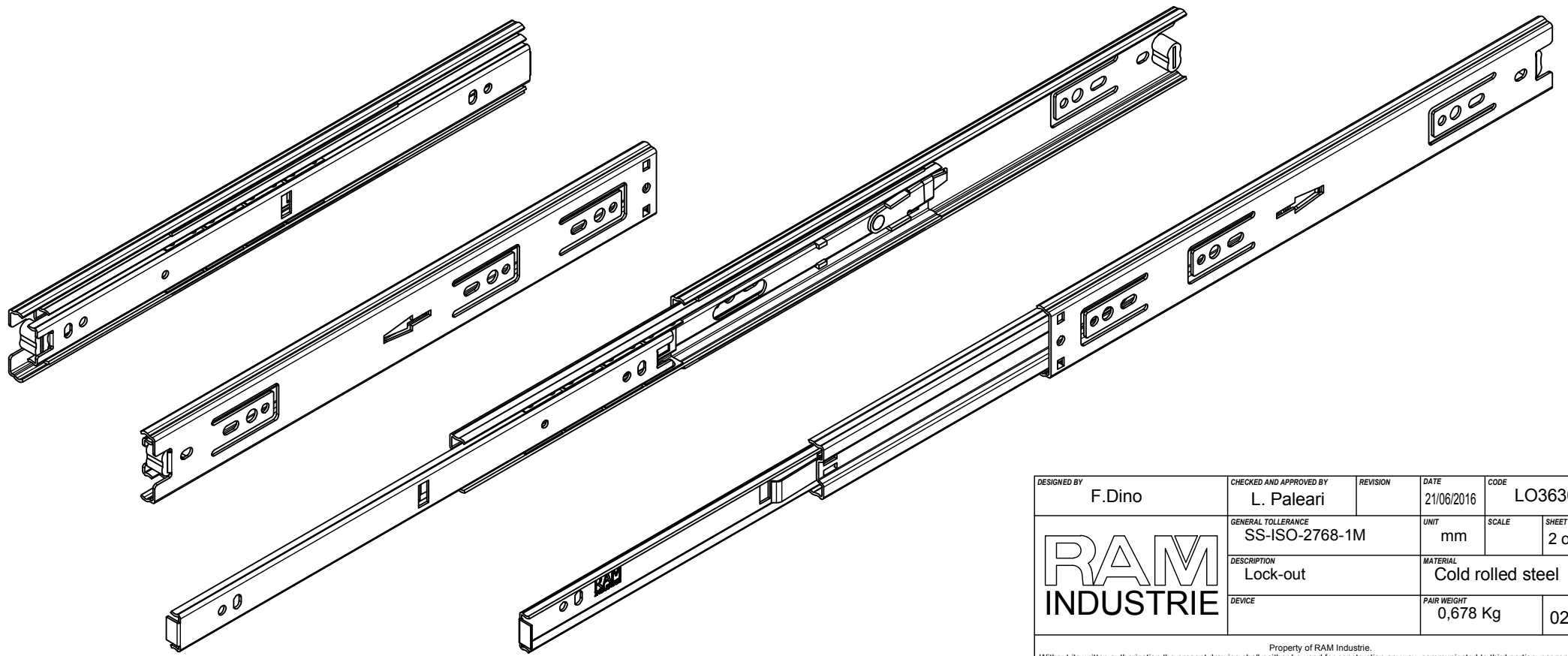
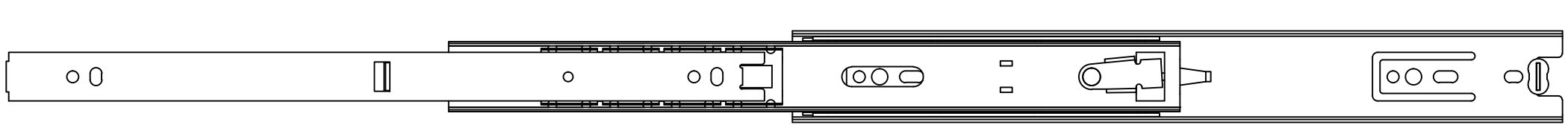

| | | | | |
|---------------------------------------------------------------------------------------------------------------------------------------------------------------------------------------------------|---------------------------------------|--------------------------------------|-------------------------------|--------------------------|
| DESIGNED BY F.Dino | CHECKED AND APPROVED BY L. Paleari | REVISION | DATE 21/06/2016 | CODE LO36300 |
|  | | GENERAL TOLLERANCE SS-ISO-2768-1M | UNIT mm | SCALE SHEET 2 of 2 |
| | | DESCRIPTION Lock-out | MATERIAL Cold rolled steel | |
| DEVICE | | PAIR WEIGHT 0,678 Kg | 02T | |
| <small>Property of RAM Industrie. Without its written authorization the present drawing shall neither be used for construction anyway, communicated to third parties, nor reproduced.</small> | | | | |